



2023





LIFE TASTES BETTER OUTDOORS



2023



BUILT FOR OUTDOOR ENTERTAINING

BeefEater are proud to manufacture outstanding barbecues and outdoor kitchens to suit all needs. We pride ourselves on great design and quality control which sees every component produced with care and precision.

Being at the forefront of the outdoor cooking market for over 30 years, we understand customers' requirements. We offer a versatile range of stylish freestanding and built-in barbecues along with purpose-built modules and accessories. Our skilled team of designers and engineers have the knowledge and vision to create your perfect outdoor cooking area.

BeefEater Europe are proud to distribute this iconic Australian barbecue brand, which is owned by Electrolux in Sydney. Our products are built to last, constructed from high grade durable materials to withstand harsh weather conditions, and to give you the ultimate outdoor cooking experience.

BARBECUES	2
RECIPES	44
ALFRESCO KITCHENS	52
SPECIFICATIONS	60
ACCESSORIES	70
SHOWROOM	76
BRANDS WE PARTNER WITH	78



B E E F E A T E R



7000 SERIES

7000 SERIES

BUILT-IN & TROLLEY

THE BBQ OF ALL BBQ'S

Welcome to our new range of built-in and freestanding BBQ's...

The large and durable cooktops are made from porcelain coated cast iron to inhibit rust and ensure you'll be cooking up a feast for years to come. Designed to heat up quickly, the surface is split between grill and solid plate, enabling you to change up your style for different foods. A generous warming rack will give you extra space and improve your overall cooking experience.

BUILT TO LAST

As with all BeefEater Barbecues, the 7000 Series is built to last.

Both burner box and roasting hood are made from 304 grade stainless steel, and we use exterior seam welds to ensure grease doesn't leak all over the patio.

DETAILS

Details are laser etched on to the control panel which eliminates fading and chipping of your control knob indicators.

Laser etching gives a durable and stylish contrast to the stainless steel.

LED LIGHTING

Now you can cook in the dark with the helpful lighting features.

The back hood lights give you great visibility when cooking at night and the LED illuminated control dials show you what power level you are on. This means you can see your food without lifting the hood and thereby maintain that perfect cooking temperature.



7000 Series Classic Built-in Barbecue



7000 Premium has a built-in 3.1kW rear burner with roasting hood lighting for better viewing and cooking conditions. The classic and premium versions have double layered hoods with large glass viewing window & integrated temperature gauge along with a full width oil & fat catchment tin. Stainless steel firebox with external seam weld for that extra durability.

7000 Series Premium Built-in Barbecue





GRILLS & PLATES

- Porcelain enamelled cast iron hotplate & grills
- Easy to clean
- Great heat retention
- Extremely durable & rust resistant
- Consistent even cooking

FEATURES

- LED lighting on dials & hood (premium version only)
- Multifunction cooking / warming rack x2
- Rear burner (premium version only)
- Integrated temperature gauge

DETAILS

- Durable 4.2kW cast stainless steel burners & stainless steel vaporisers
- Fully welded 304 grade stainless steel fire box & stainless steel elevated cooking rack
- Quartz start ignition



7000 Series Premium 5 Burner Free-Standing



7000 Premium or 7000 Classic 5 Burner with premium trolley



ICEBOX & CHOPPING BOARD

- Icebox concealed to keep your drinks chilled
- Prepare your food with ease
- Removable & easy to clean
- Soft closing lid
- Extra space to work with



ACCESSORY RAIL

- Both sides of the trolley
- Organise all accessories to customize your cooking area
- Easy to reach to help with all your cooking needs
- Perfect for cooking multiple foods



SIDE BURNER

- Cast iron trivet
- Brass burner cap disperses flame
- Cast stainless steel body
- Quartz start ignition on all burners
- Lid folds down for use as a table

1200 SERIES

BUILT-IN & TROLLEY

BUILT TO LAST

Thick gauge porcelain enamelled steel burner box which is entirely enclosed and seam welded to ensure a consistent chamber performance, even in windy conditions, and prevent grease leaks on your patio.

SIDE BURNER SHELF

Cook delicious stir fries with a powerful built-in wok burner which also doubles up as a side shelf when not in use.

GRILL & GRIDDLE

Cast iron cook tops with versatile grill and griddle options.

FULL CONTROL

4 heavy duty lockable swivel castors for easy mobility.

TASTE THE POWER

Seal in the flavour with our durable and powerful 4kW cast iron rail burners.

SNUG FIT

A rollback hood that allows the BBQ to sit snugly against the wall.



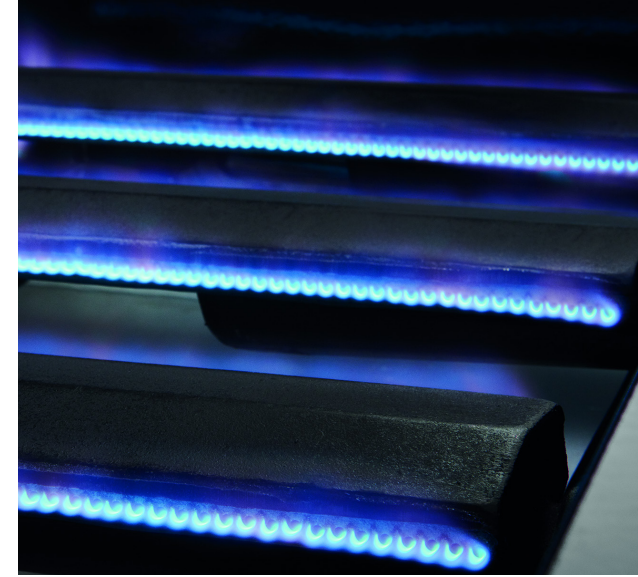

Flavourful food without the fuss. Cook more delicious food on the spacious cast iron cooktop that will heat evenly and retain temperature for better cooking results.

The cooktop is porcelain coated which offers protection from rust and ensures it will last longer. The integrated warming rack designed to keep your food warm until you are ready for it can easily be moved out of the way when you don't need it.

Cleaning made easy. The grease management system ensures oil and residues are either vaporized or channelled down to the easily removable drip tray.

Check your food whilst retaining the heat with the large viewing window, which makes cooking on a BBQ so much easier. Keep all the flavour sealed in so everything simply tastes better.





GRILLS & PLATES

- Porcelain enamelled cast iron hotplate & grills
- Easy to clean
- Great heat retention
- Extremely durable & rust resistant
- Consistent even cooking

FEATURES

- Front access full width drip tray
- Raised edge around the hotplate which means no overflow
- Removeable multifunction cooking / warming rack
- Integrated temperature gauge

SIDE BURNER

- Cast iron trivet
- Brass burner cap disperses flame
- Enamelled / stainless steel body
- Quartz start ignition
- Lid folds down for use as a table

1500 SERIES

BUILT-IN & TROLLEY

STYLISH CONTROL PANEL

Close the control cover panel for a seamless look when the BBQ is not in use and then flip it down for a handy little shelf when you're cooking.

FULL CONTROL

4 heavy duty lockable swivel castors for easy mobility.

TIDY STORAGE

Full capacity storage cabinet to keep essentials tidy.

SNUG FIT

A rollback hood that allows the BBQ to sit snugly against the wall.

TASTE THE POWER

Seal in the flavour with our durable and powerful 4kW cast iron rail burners.

DETAILS

Cover panel created to look like wood, making it perfect for fitting in with a variety of different surroundings.





Making cooking easy and quick with the quartz start ignition, first time every time. The easy start ignition system makes sparking up the BBQ a breeze.

Creating that perfect roast is easy with our double layered hood and integrated temperature gauge. Sear your cut of meat on the cast iron plate and then set your chamber temperature for outstanding flavour every time.

The spacious cast iron cook top ensures quality cooking performance. A protective enamel coating makes them durable and easy to clean.

As well as this being a great barbecue, the 1500 Series also features a stylish control panel cover which folds down for use as a handy shelf when you are cooking.



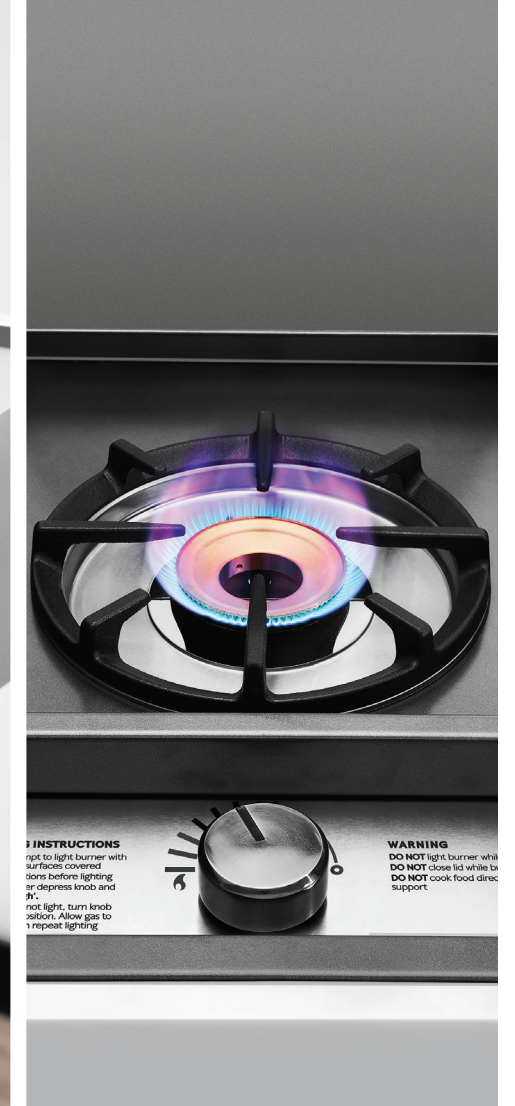
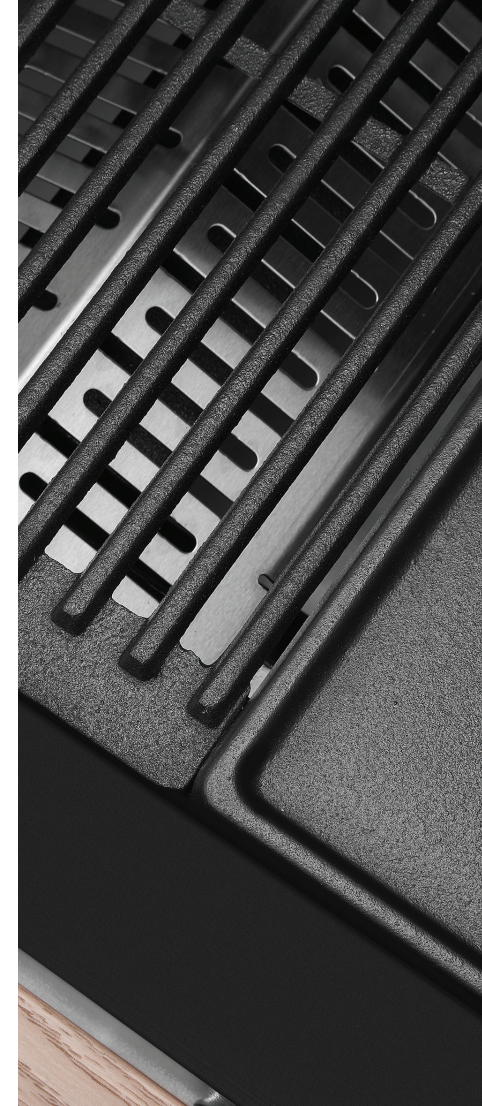

GRILLS & PLATES

- Porcelain enamelled cast iron hotplate and grills
- Easy to clean
- Great heat retention
- Extremely durable & rust resistant
- Consistent even cooking

FEATURES

- Drop down wood effect shelf
- Hotplate doubles up as a flat plate or griddle plate.
- Elevated multifunction cooking / warming rack

SIDE BURNER

- Cast iron trivet
- Brass burner cap disperses flame
- Stainless steel body
- Quartz start ignition on all burners
- Lid folds down for use as a table

1600 SERIES

BUILT-IN & TROLLEY

KEEP ALL THE FLAVOUR SEALED IN

Seal in the flavour with powerful cast iron burners, cook with consistent heat to give you the delicious results you're looking for.

SIDE BURNER SHELF

Cook tasty stir fries with the powerful built-in wok burner.

GRILL & GRIDDLE

Cast iron cook tops with a versatile grill and griddle options.

CLASS LEADING

Double skin stainless steel roasting hood with integrated temperature gauge for top class indirect cooking.

SEE FOR YOURSELF

Extra-large viewing window lets you see what's going on under the roasting hood.

SPACIOUS

Large cooking area, side shelves and trolley cupboards for storing and preparing everything you need for your perfect barbecue experience.





With cast iron burners and stainless steel vaporisers, you have one of the most durable, flexible, and efficient cooking systems available. The cast iron heats up quickly and maintains a consistent temperature. The stainless steel vaporisers very efficiently disperse the flames across the grill and plate surfaces whilst reducing flare ups.

The large viewing window means you can keep a careful eye on your food without lifting the hood and losing that all important oven chamber temperature. There is a chrome wired elevated cooking rack that keeps your food warm when it's done or you can use it as a second cooking area.

Control each burner with a separate knob, allowing you to be in full control of the heat. Turn the hotplate burners up for searing and the grill burners down for that slow cook.

Raised edges on the hotplate prevents grease or oil spilling over and the grease management system ensures they are either vaporized or channelled down to the easily removeable drip tray.





GRILLS & PLATES

- Porcelain enamelled cast iron hotplate and grills
- Easy to clean
- Great heat retention
- Extremely durable & rust resistant
- Consistent even cooking

FEATURES

- Double layer rollback hood with large glass viewing window
- Integrated temperature gauge
- Easy read control knob & bezels
- Fully seam welded vitreous fire box
- Multifunctional cooking / warming rack

SIDE BURNER

- Cast iron trivet
- Brass burner cap disperses flame
- Graphite / Stainless steel finishes
- Quartz start ignition
- Lid folds down for use as a table

3000E SERIES

BUILT-IN

PACKED WITH FEATURES

Crafted from black enamelled steel for maximum style and durability. Stainless steel vaporisers and heat reflectors to promote power and control the flame for maximum flavour.

EVEN HEAT DISTRIBUTION

Cast iron burners with 72 apertures per burner for maximum heat. There are stainless steel reflectors that sit between and underneath the burners. Along with that the stainless steel vaporisers prevent direct flame contact with the cooking surface.

DURABILITY

Heavy duty cast iron cook tops with our unique V-shaped channels on the grill and cambered plate.

DETAILS

Integrated convection roasting hood with a large removeable warming rack. The hood also features a durable BeefEater badge and an integral temperature gauge.

SNUG FIT

A rollback hood that allows the BBQ to sit snugly against the wall.

DESIGN

Beautifully crafted to suit all needs, stylish and built to last, the 3000E is a classic all round fantastic BBQ.





With an integrated easy clean convection roasting hood, you can now experience cooking to perfection in easy clean vitreous enamel. The roasting hood also includes an on-board warming rack and temperature gauge. The cooktop is created from porcelain enamel coated cast-iron which makes it very durable and rust resistant. This is one of the toughest coatings available and the cooktop is built to last.

The vaporiser grid reflector system with anti-flare technology reduces unwanted flare-ups and heat loss for faster cooking and superior fuel economy. Along with that, our innovative integrated quartz start ignition is a titanium-coated system that ensures durable and hassle-free starting. Fires up the first time, every time.



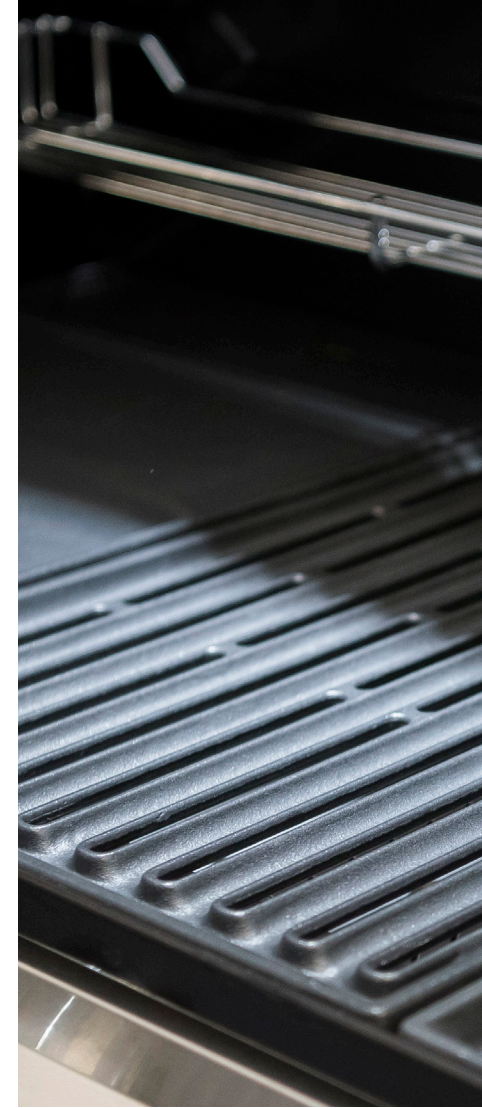

GRILLS & PLATES

- Porcelain enamelled cast iron hotplate and grills
- Easy to clean
- Great heat retention
- Extremely durable & rust resistant
- Consistent even cooking



FEATURES

- Large viewing window to assist when indirect cooking
- Stainless steel drip tray for longevity in grease management
- Multifunction cooking / warming rack, raised and hood hinged



DETAILS

- Integrated temperature gauge
- Hardwearing BeefEater badge
- Black enamel body
- Quartz start ignition on all burners
- Seam welded burner box

PROLINE®

BUILT-IN

OUTDOOR ENTERTAINING NEVER LOOKED SO GOOD

With a sleek linear design and uncompromising power, our ProLine® series integrated barbecues offer an array of premium features such as multipurpose cast iron furnishings, a powerful quad burner, and a superior oil management system.

It's everything you want in a barbecue and more.

DESIGNED TO LAST

The ProLine® is built for style and durability with the six 304 grade stainless steel tubular burners, with a total rating of 18.6kW. The heavy duty cast iron cook tops combine with stainless steel vaporisers and an electronic ignition to provide superior cooking performance.

The roasting hood model features flame failure safety technology.

STYLE DETAILS

Intuitive side mounted controls with laser etched power level indicators.

ACCESSORIES

Optional barbecue extras available for both models to broaden your cooking experience so you can cook a variety of foods to please all your guests or simply a perfect feast for family.



25 YRS
WARRANTY



With its distinctive linear design, the BeefEater ProLine® barbecue range is sure to impress. Sleek lines, cutting-edge style and a top-class range of innovative features have created the perfect addition to your outdoor entertaining area.

The cast hotplate is designed to fit over the four centre burners of the barbecue, this clever cast iron hotplate will have you cooking like a pro. With one control igniting two burners at a time, simply select your desired heat level and enjoy the ideal set-up for consistently even grilling, searing, or roasting.

With the superior oil management system, it is a healthier cooking and an easy-to-clean barbecue. Oil and waste run into easily removable containers at the front of the barbecue, while the unique angled surface drains oil away from food.



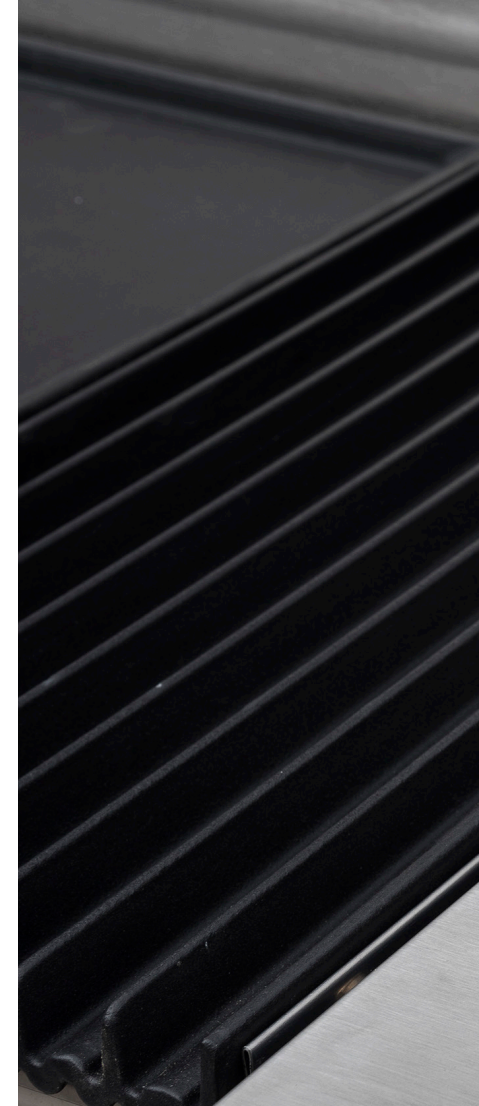

GRILLS & PLATES

- Porcelain enamelled cast iron hotplate and grills
- Easy to clean
- Great heat retention
- Extremely durable & rust resistant
- Consistent even cooking

FEATURES

- Laser etched badge and controls
- Intuitive side mounted controls
- Multifunction cooking/ warming rack (Roasting hood only)
- 304 stainless steel tubular burners x6
- Flame failure on Roaster models

SIDE BURNER

- Powerful Quad Burner™
- Made for durability & style
- Electronic ignition on all burners
- Optional barbecue extras available

CLUBMAN

TROLLEY

FREEDOM OF COOKING ANYWHERE

Whether you're hosting a big family event or entertaining friends at the local park, enjoy the freedom of cooking anywhere outdoors with the BeefEater Clubman.

Designed for mobility and durability, its convenient folding legs and huge cooking area make it ideal for any occasion. Perfect for families, schools and sporting clubs, the BeefEater Clubman can handle anything you can throw at it, or on it. Choose from stainless steel or black mild steel finish.

Bringing people together... with the clubman you can enjoy the freedom of cooking from anywhere outdoors with the easy access removable plate, front grease cup and weatherproof lid.



Stainless Steel



Mild Steel



COOKING AREA

- Large 5mm thick cooking plate
- 304 grade stainless steel or food safe painted mild steel
- Great heat retention
- Extremely durable & rust resistant
- Consistent even cooking



FEATURES

- Folding legs & side shelf for easy transportation
- Includes rain lid and handle
- 4 heavy duty lockable swivel castors for easy mobility
- Powerful burners which heat the plate quick and evenly



CONTROL

- Innovative titanium coated system
- Made for durability & hassle free
- Quartz start ignition system
- Heavy duty componentry
- Easy to control heat and power



FRIDGES

BUILT-IN

POWER & PRECISION

The BeefEater range of outdoor bar fridges have the power to keep your drinks perfectly chilled on even the hottest days.

Designed for outdoor use, the BeefEater fridge has been tested to 43°C in the shade and has a 304 grade stainless steel finish, making it ideal for use even in a harsh climate.

The insulated and heated double glazed glass doors allow you to see all your drinks at a glance and prevents condensation for even better visibility.

IPX4 rated – the cabinet is protected against splashes of water for at least 5 minutes, making it perfect for use within a built-in outdoor kitchen.

The electronic controls allow you to set the temperature for your cabinet at the touch of a button, with a temperature range of 0°C - 10°C.



120L SINGLE DOOR OUTDOOR BAR FRIDGE
555W x 495D x 850H mm
28131 UK Plug
28132 EU Plug



190L DOUBLE DOOR OUTDOOR BAR FRIDGE
865W x 495D x 850H mm
28201 UK Plug
28202 EU Plug

Thai Salmon

with cucumber and dipping sauce

Serves 4

Ingredients

1 thumb sized red chilli, deseeded and finely chopped

2 garlic cloves, finely chopped

1 tablespoon fish sauce

1 tablespoon sesame oil

2 tablespoons honey

¼ cucumber, diced

1 red onion, diced

4 tablespoons sweet chilli sauce, mixed with a squeeze of lime juice and a handful of coriander roughly chopped

Method

1. Put the salmon in a bowl with the chilli, garlic, coriander, fish sauce, sesame oil and honey.
2. Season with pepper and refrigerate for at least 20 minutes or overnight.
3. Heat BeefEater® BBQ to medium heat.
4. Grill or barbecue the salmon until it is crisp at the edges. If you like it cooked all the way through rather than rare in the middle then keep cooking until the fish feels very firm to the touch.
5. Serve with the cucumber and onion sprinkled over and the sweet chilli dipping sauce.



Moroccan Burgers

Serves 4

Ingredients

1kg of coarsely minced meat from beef, lamb, pork or chicken with a fat content of approx. 30% (chicken 20%)

1 large onion finely chopped

1 cup of roughly chopped coriander

1 tablespoon of smoked paprika

1 tablespoon of ground cumin

1 teaspoon of ground coriander seeds

1 teaspoon of turmeric

1 teaspoon of grated ginger (optional)

2 tablespoons of breadcrumbs

Method

1. With your hands knead all ingredients into a bowl together and shape 4 or 6 burger patties of the thickness of your thumb and slightly larger than your bun.

2. Place onto the griddle or flat plate of your BeefEater® BBQ (medium-high heat) and cook for approximately three minutes on each side and turning it carefully with a scraper rather than tongs.

3. Check the cooking stages/temperatures where a beef or lamb burger is perfect when cooked medium to well and pork at medium well and chicken at well done.

4. When cooked remove from the heat to avoid overcooking which will result in dry and chewy burgers.

5. Cut the buns in half and shortly before your burgers are ready toast the buns (first cut side down) on the BBQ on both sides and start assembling them with your chosen fillings and serve.



Chilli and Garlic Beef Steaks

Serves 4

Ingredients

- ¼ cup of brown sugar
- 2 tablespoons of smoked paprika
- 1 teaspoon of ground black pepper
- 1 tablespoon of salt
- 1 tablespoon of chilli powder
- 1 tablespoon of garlic powder
- 1 tablespoon of onion powder
- 1 tablespoon of dried oregano
- 4 beef steaks (rib eye on the bone, sirloin or rump)

Method

1. To make the rub, place all ingredients except for meat into a food processor (or mortar) and process into a powder.
2. Massage rub into the meat and let it stand for 10-20 minutes.
3. Preheat your BeefEater® BBQ and cook meat on medium heat until it is cooked to your liking (approx. 3 mins on each side for medium rare).
4. Rest meat for 5-10 minutes before serving.



Maple Baked BBQ Bananas

with vanilla bean ice cream

Serves 4

Ingredients

6 sugar bananas peeled, split in half

12-star anise

3 cinnamon sticks cut in half

6 dessert spoons of maple syrup

Zest of one large orange

6 sheets of grease proof

6 sheets of Aluminium foil

Vanilla ice cream of your choice

Method

1. Lay out 6 sheets of aluminium foil on the kitchen bench.
2. Lay the grease proof paper over the top of the aluminium.
3. Fold all four corners together to form a bowl like appearance.
4. Then place the banana flesh in the 'paper bowl' and share all the other ingredients equally between the bananas.
5. Close the parcels up by crimping the foil together at the top.
6. Place on your BeefEater® BBQ plate or grill and cook on a low heat for 8-10 minutes.
7. Once cooked open the envelopes in front of your guests so they can smell the aromas of the baked bananas and serve with your favourite vanilla ice cream.



ALFRESCO KITCHENS

TAKE OUTDOOR TO THE NEXT LEVEL

Whether you're a serial entertainer, or the occasional Sunday meal host, our vast range means we have the right stylish, premium outdoor kitchen for you.

BeefEater Alfresco Kitchens enables you to design and choose all the elements you need for luxury outdoor living and effortless entertaining. Choose all the elements you need for your BBQ kitchen to turn your dream into reality.

With a variety of straight line configurations to suit your taste, it's an entertainer's dream, and it's all yours with BeefEater.

PERFECTION

These outdoor kitchens are built to last and survive even the harshest of conditions. Manufactured from high grade materials and featuring soft closing doors, these wonderful products will transform your outdoor area.

BEEFEATER BARBECUES

All these kitchens suit a selection of the BeefEater barbecues so not only can you design the kitchens, but you can also have a choice at what BeefEater barbecue to build into it. This is a superb combination and creates your ideal outdoor area... Beauty and excellence all in one.

Harmony® 54

ProLine® 58





Harmony® 4 Burner Kitchen with double cupboard, double fridge, sink & tap.

PREMIUM QUALITY QUARTZ STONE WORKTOPS

Not only do they look great but they are easy to clean. High heat tested to withstand 150 degrees without scorching or cracking.

DURABLE CONSTRUCTION FOR OUTDOOR LIVING

Carefully constructed with durable marine grade ply cabinets and German Blum hinges.

1200E 4 & 5 Burner Built-in



1200S 4 & 5 Burner Built-in



3000E 4 & 5 Burner Built-in



1600S 4 & 5 Burner Built-in



1600E 4 & 5 Burner Built-in



Harmony® Outdoor Kitchens are compatible with the above BeefEater Barbecues



Harmony® 4 Burner Kitchen

with 2 Single Cupboards

BOK40WG

Height 900mm
Width 2290mm
Depth 600mm

Harmony® 5 Burner Kitchen

with 2 Single Cupboards

BOK50WG

Height 900mm
Width 2468mm
Depth 600mm



Harmony® 4 Burner Kitchen

with Single Cupboard, Single Fridge

BOK41WG

Height 900mm
Width 2290mm
Depth 600mm

Harmony® 5 Burner Kitchen

with Double Cupboard, Double Fridge

BOK53WG

Height 900mm
Width 3110mm
Depth 600mm



Harmony® 4 Burner Kitchen

with Single Cupboard, Double Fridge

BOK43WG

Height 900mm
Width 2560mm
Depth 600mm

Harmony® 5 Burner Kitchen

with Double Fridge, Single Cupboard,
Double Cupboard, Sink & Tap

BOK56WG

Height 900mm
Width 3600mm
Depth 600mm



Harmony® 4 Burner Kitchen

with Double Fridge, Double Cupboard,
Sink & Tap

BOK44WG

Height 900mm
Width 2870mm
Depth 600mm

These kitchens are paired with the BeefEater outdoor bar fridge, either the 120L or 190L which will keep your drinks perfectly chilled whilst you cook. The sink and tap are manufactured from stainless steel for the high durability and work well with the beautifully crafted worktops.

The units also have adjustable feet up to 25mm to accommodate for uneven flooring so installing your kitchen can be stress free.

*BOK4*** codes are compatible with BeefEater 4 burner built-in barbecues and BOK5*** are compatible with BeefEater 5 burner built-in barbecues.*



ProLine® 6 Burner Kitchen with roasting hood, quad burner & 4 single cupboards.

PROLINE®

The ultimate outdoor kitchen style with the elegant ProLine® 6 burner barbecue and quad burner. This stylish and sleek design is exceptional from the look to the function. The quad side burner is a perfect extra to sauté your vegetables and with a broad range of different accessories means you can create different configurations to create your ideal cooking set up.

Clean design lines and 40mm Quartz stonework tops for the top of the range kitchen makes this countertop very durable and stable. Beautifully finished this really is an exquisite and most admirable component to complete your outdoor space to entertain or relax.

ProLine® 6 Burner Kitchen

with Roasting Hood, Quad Burner & 4 Single Cupboards

BOKP60WG

Height	Width	Depth
900mm	1900mm	700mm



ProLine® 6 Burner Kitchen

with Roasting Hood, Quad Burner, 5 Single Cupboards & Double Fridge

BOKP61WG

Height	Width	Depth
900mm	3305mm	700mm



1200S Series 3 Burner

Stainless Steel Built-in BBQ

BBG1230SBE



Cast Iron cook pack BBG1230SBE		NG Kit 95176	Rotisserie SP-638-BE	Cover 94493	Built-In Kit BA12HS		
Cook Area 3072cm sq	Grill 320mm	Plate 320mm	Height 499mm	Width 687mm	Depth 568mm	Weight 43kg*	MJ/hr 43

1200S Series 4 Burner

Stainless Steel Built-in BBQ

BBG1240SBE



Cast Iron cook pack BBG1240SBE		NG Kit 95176	Rotisserie SP-638-BE	Cover 94494	Built-In Kit BA12HS		
Cook Area 3840cm sq	Grill 400mm	Plate 400mm	Height 499mm	Width 837mm	Depth 568mm	Weight 51kg*	MJ/hr 58

1200S Series 5 Burner

Stainless Steel Built-in BBQ

BBG1250SBE



Cast Iron cook pack BBG1250SBE		NG Kit 95176	Rotisserie SP-638-BE	Cover 94495	Built-In Kit BA12HS		
Cook Area 4608cm sq	Grill 640mm	Plate 320mm	Height 499mm	Width 1007mm	Depth 568mm	Weight 58kg*	MJ/hr 72

1200E Series 3 Burner

Black Enamel Built-in BBQ

BBG1230BBE



Cast Iron cook pack BBG1230BBE		NG Kit 95176	Rotisserie SP-638-BE	Cover 94493	Built-In Kit BA12HS		
Cook Area 3072cm sq	Grill 320mm	Plate 320mm	Height 499mm	Width 687mm	Depth 568mm	Weight 43kg*	MJ/hr 43

1200E Series 4 Burner

Black Enamel Built-in BBQ

BBG1240BBE



Cast Iron cook pack BBG1240BBE		NG Kit 95176	Rotisserie SP-638-BE	Cover 94494	Built-In Kit BA12HS		
Cook Area 3840cm sq	Grill 400mm	Plate 400mm	Height 499mm	Width 837mm	Depth 568mm	Weight 51kg*	MJ/hr 58

1200E Series 5 Burner

Black Enamel Built-in BBQ

BBG1250BBE



Cast Iron cook pack BBG1250BBE		NG Kit 95176	Rotisserie SP-638-BE	Cover 94495	Built-In Kit BA12HS		
Cook Area 4608cm sq	Grill 640mm	Plate 320mm	Height 499mm	Width 1007mm	Depth 568mm	Weight 58kg*	MJ/hr 72

1500 Series 3 Burner

Stainless Steel Built-in BBQ

BDB1530GA



Cast Iron cook pack BDB1530GA		NG Kit 95176	Cover BACB153	Built-in Bracket BA7OHS			
Cook Area 3072cm sq	Grill 320mm	Plate 320mm	Height 474mm	Width 654mm	Depth 584mm	Weight 43kg*	MJ/hr 43

1500 Series 4 Burner

Stainless Steel Built-in BBQ

BDB1540GA



Cast Iron cook pack BDB1540GA		NG Kit 95176	Cover BACB154	Built-in Bracket BA7OHS			
Cook Area 3840cm sq	Grill 400mm	Plate 400mm	Height 474mm	Width 804mm	Depth 584mm	Weight 51kg*	MJ/hr 58

1500 Series 5 Burner

Stainless Steel Built-in BBQ

BDB1550GA



Cast Iron cook pack BDB1550GA		NG Kit 95176	Cover BACB155	Built-in Bracket BA7OHS			
Cook Area 4608cm sq	Grill 640mm	Plate 320mm	Height 474mm	Width 974mm	Depth 584mm	Weight 58kg*	MJ/hr 72



1500 Control Panel



1500 Integrated Temperature Gauge



1500 Grill and Vaporiser

*Approximate Weight

1600S Series 3 Burner

Stainless Steel Built-in BBQ

BBG1630SAE



Cast Iron cook pack BBG1630SAE		NG Kit 95176	Rotisserie SP-638-BE	Cover BACB153	Built-In Kit BA70HS		
Cook Area 3072cm sq	Grill 320mm	Plate 320mm	Height 517mm	Width 698mm	Depth 555mm	Weight 43kg*	MJ/hr 43

1600S Series 4 Burner

Stainless Steel Built-in BBQ

BBG1640SAE



Cast Iron cook pack BBG1640SAE		NG Kit 95176	Rotisserie SP-638-BE	Cover BACB154	Built-In Kit BA70HS		
Cook Area 3840cm sq	Grill 400mm	Plate 400mm	Height 517mm	Width 804mm	Depth 555mm	Weight 51kg*	MJ/hr 58

1600S Series 5 Burner

Stainless Steel Built-in BBQ

BBG1650SAE



Cast Iron cook pack BBG1650SAE		NG Kit 95176	Rotisserie SP-638-BE	Cover BACB155	Built-In Kit BA70HS		
Cook Area 4608cm sq	Grill 640mm	Plate 320mm	Height 517mm	Width 975mm	Depth 555mm	Weight 58kg*	MJ/hr 72

1600E Series 3 Burner

Graphite Stainless Steel Built-in BBQ

BBG1630DAE



Cast Iron cook pack BBG1630DAE		NG Kit 95176	Rotisserie SP-638-BE	Cover BACB153	Built-In Kit BA70HS		
Cook Area 3072cm sq	Grill 320mm	Plate 320mm	Height 517mm	Width 698mm	Depth 555mm	Weight 43kg*	MJ/hr 43

1600E Series 4 Burner

Graphite Stainless Steel Built-in BBQ

BBG1640DAE



Cast Iron cook pack BBG1640DAE		NG Kit 95176	Rotisserie SP-638-BE	Cover BACB154	Built-In Kit BA70HS		
Cook Area 3840cm sq	Grill 400mm	Plate 400mm	Height 517mm	Width 804mm	Depth 555mm	Weight 51kg*	MJ/hr 58

1600E Series 5 Burner

Graphite Stainless Steel Built-in BBQ

BBG1650DAE



Cast Iron cook pack BBG1650DAE		NG Kit 95176	Rotisserie SP-638-BE	Cover BACB155	Built-In Kit BA70HS		
Cook Area 4608cm sq	Grill 640mm	Plate 320mm	Height 517mm	Width 975mm	Depth 555mm	Weight 58kg*	MJ/hr 72

S3000E Series 3 Burner

Black Enamel Built-in BBQ

19932



Cast Iron cook pack 19932		NG Kit 95174	Rotisserie SP-638-BE	Cover 94493	Built-In Kit 23133		
Cook Area 3072cm sq	Grill 320mm	Plate 320mm	Height 525mm	Width 660mm	Depth 570mm	Weight 55kg*	MJ/hr 57

S3000E Series 4 Burner

Black Enamel Built-in BBQ

19942



Cast Iron cook pack 19942		NG Kit 95174	Rotisserie SP-638-BE	Cover 94494	Built-In Kit 23134		
Cook Area 3840cm sq	Grill 400mm	Plate 400mm	Height 525mm	Width 816mm	Depth 570mm	Weight 65kg*	MJ/hr 76

S3000E Series 5 Burner

Black Enamel Built-in BBQ

19952



Cast Iron cook pack 19952		NG Kit 95174	Rotisserie SP-638-BE	Cover 94495	Built-In Kit 23135		
Cook Area 4608cm sq	Grill 640mm	Plate 320mm	Height 525mm	Width 973mm	Depth 570mm	Weight 68kg*	MJ/hr 95



3000E Plate and Grill



3000E Cooking/ Warming Rack



3000E Integrated Temperature Gauge

*Approximate Weight

NEW 7000 Series Classic 4 Burner

Stainless Steel Built-in BBQ

BBG7640SAE



Cast Iron cook pack BBG7640SAE		NG Kit 95182	Rotisserie SP-638-BE	Cover BACB704	Built-In Kit BA55HS		
Cook Area 3740cm sq	Grill 195mm x2	Plate 380mm	Height 555mm	Width 817mm	Depth 628mm	Weight 65kg*	MJ/hr 68

NEW 7000 Series Classic 5 Burner

Stainless Steel Built-in BBQ

BBG7650SAE



Cast Iron cook pack BBG7650SAE		NG Kit 95182	Rotisserie SP-638-BE	Cover BACB705	Built-In Kit BA55HS		
Cook Area 4480cm sq	Grill 270mm x2	Plate 380mm	Height 555mm	Width 973mm	Depth 628mm	Weight 68kg*	MJ/hr 85

NEW 7000 Series Premium 4 Burner

Stainless Steel Built-in BBQ

BBF7645SAE



Cast Iron cook pack BBF7645SAE		NG Kit 95182	Rotisserie SP-638-BE	Cover BACB704	Built-In Kit BA55HS		
Cook Area 3740cm sq	Grill 195mm x2	Plate 380mm	Height 555mm	Width 817mm	Depth 628mm	Weight 65kg*	MJ/hr 85

NEW 7000 Series Premium 5 Burner

Stainless Steel Built-in BBQ

BBF7655SAE



Cast Iron cook pack BBF7655SAE		NG Kit 95182	Rotisserie SP-638-BE	Cover BACB705	Built-In Kit BA55HS		
Cook Area 4480cm sq	Grill 270mm x2	Plate 380mm	Height 555mm	Width 973mm	Depth 628mm	Weight 68kg*	MJ/hr 105



7000P Control Dial Lighting



7000P Viewing Window



7000 Series Vaporiser

ProLine® 6 Burner with Roasting Hood

Stainless Steel Built-in BBQ with Anti-Flare Technology

BSH158SAEUGB



Cast Iron cook pack BSH158SAEUGB		Griller Pack BACS102A	Cover BACS200A	Built-In Kit BACS100A			
Cook Area 4176cm sq	Grill 430mm	Plate 430mm	Height 212mm	Width 1053mm	Depth 540mm	Weight 63.5kg*	MJ/hr 71

ProLine® 6 Burner with Removable Flatlid

Stainless Steel Built-in BBQ with Anti-Flare Technology

BSL158SAEUGB



Cast Iron cook pack BSL158SAEUGB		Griller Pack BACS102A	Cover BACS201A	Built-In Kit BACS100A			
Cook Area 4176cm sq	Grill 430mm	Plate 430mm	Height 42mm	Width 1053mm	Depth 540mm	Weight 54.5kg*	MJ/hr 71

ProLine® Quad Burner with Removable Flatlid

Stainless Steel Built-in Side Burner

BSW318SAEUGB



Cast Iron cook pack BSW318SAEUGB		Griller Pack ACC178	Cover BACS202A	Built-In Kit BACS101A			
Height 42mm	Width 350mm	Depth 540mm	Weight 18kg*	MJ/hr 23			



ProLine® Cooking/Warming Rack



ProLine® Lasered Badge



ProLine® Roasting Hood



1200S Series 3 Burner

Stainless Steel Freestanding BBQ with Side Burner Trolley

BMG1231SBE

Cast Iron cook pack BMG1231SBE	NG Kit 95176	Rotisserie SP-638-BE	Cover 94463				
Cook Area 3072cm sq	Grill 320mm	Plate 320mm	Height 1217mm	Width 1377mm	Depth 602mm	Weight 63kg*	MJ/hr 58



1200S Series 4 Burner

Stainless Steel Freestanding BBQ with Side Burner Trolley

BMG1241SBE

Cast Iron cook pack BMG1241SBE	NG Kit 95176	Rotisserie SP-638-BE	Cover 94464				
Cook Area 3840cm sq	Grill 400mm	Plate 400mm	Height 1217mm	Width 1527mm	Depth 602mm	Weight 77kg*	MJ/hr 72



1200S Series 5 Burner

Stainless Steel Freestanding BBQ with Side Burner Trolley

BMG1251SBE

Cast Iron cook pack BMG1251SBE	NG Kit 95176	Rotisserie SP-638-BE	Cover 94465				
Cook Area 4608cm sq	Grill 640mm	Plate 320mm	Height 1217mm	Width 1697mm	Depth 602mm	Weight 91kg*	MJ/hr 86



1200E Series 3 Burner

Black Enamel Freestanding BBQ with Side Burner Trolley

BMG1231BBE

Cast Iron cook pack BMG1231BBE	NG Kit 95176	Rotisserie SP-638-BE	Cover 94463				
Cook Area 3072cm sq	Grill 320mm	Plate 320mm	Height 1217mm	Width 1377mm	Depth 602mm	Weight 63kg*	MJ/hr 58



1200E Series 4 Burner

Black Enamel Freestanding BBQ with Side Burner Trolley

BMG1241BBE

Cast Iron cook pack BMG1241BBE	NG Kit 95176	Rotisserie SP-638-BE	Cover 94464				
Cook Area 3840cm sq	Grill 400mm	Plate 400mm	Height 1217mm	Width 1527mm	Depth 602mm	Weight 77kg*	MJ/hr 72



1200E Series 5 Burner

Black Enamel Freestanding BBQ with Side Burner Trolley

BMG1251BBE

Cast Iron cook pack BMG1251BBE	NG Kit 95176	Rotisserie SP-638-BE	Cover 94465				
Cook Area 4608cm sq	Grill 640mm	Plate 320mm	Height 1217mm	Width 1697mm	Depth 602mm	Weight 91kg*	MJ/hr 86



1500 Series 3 Burner

Stainless Steel Freestanding BBQ with Side Burner Trolley

BDM1530GA

Cast Iron cook pack BDM1530GA	NG Kit 95176	Cover BACM153					
Cook Area 3072cm sq	Grill 320mm	Plate 320mm	Height 1152mm	Width 1522mm	Depth 639mm	Weight 63kg*	MJ/hr 58



1500 Series 4 Burner

Stainless Steel Freestanding BBQ with Side Burner Trolley

BDM1540GA

Cast Iron cook pack BDM1540GA	NG Kit 95176	Cover BACM154					
Cook Area 3840cm sq	Grill 400mm	Plate 400mm	Height 1152mm	Width 1672mm	Depth 639mm	Weight 77kg*	MJ/hr 72



1500 Series 5 Burner

Stainless Steel Freestanding BBQ with Side Burner Trolley

BDM1550GA

Cast Iron cook pack BDM1550GA	NG Kit 95176	Cover BACM155					
Cook Area 4608cm sq	Grill 640mm	Plate 320mm	Height 1152mm	Width 1842mm	Depth 639mm	Weight 91kg*	MJ/hr 86



1500 Trolley Side Burner



1500 Cooking/ Warming Rack



1500 Fold Down Control Panel/ Shelf



1600S Series 3 Burner

Stainless Steel Freestanding BBQ with Side Burner Trolley

BMG1631SBE

Cast Iron cook pack BMG1631SBE		NG Kit 95176	Rotisserie SP-638-BE	Cover BACM153			
Cook Area 3072cm sq	Grill 320mm	Plate 320mm	Height 1200mm	Width 1522mm	Depth 686mm	Weight 63kg*	MJ/hr 58



1600S Series 4 Burner

Stainless Steel Freestanding BBQ with Side Burner Trolley

BMG1641SBE

Cast Iron cook pack BMG1641SBE		NG Kit 95176	Rotisserie SP-638-BE	Cover BACM154			
Cook Area 3840cm sq	Grill 400mm	Plate 400mm	Height 1200mm	Width 1670mm	Depth 686mm	Weight 77kg*	MJ/hr 72



1600S Series 5 Burner

Stainless Steel Freestanding BBQ with Side Burner Trolley

BMG1651SBE

Cast Iron cook pack BMG1651SBE		NG Kit 95176	Rotisserie SP-638-BE	Cover BACM155			
Cook Area 4608cm sq	Grill 640mm	Plate 320mm	Height 1200mm	Width 1840mm	Depth 686mm	Weight 91kg*	MJ/hr 86



1600E Series 3 Burner

Graphite Stainless Steel Freestanding BBQ with Side Burner Trolley

BMG1631BBE

Cast Iron cook pack BMG1631BBE		NG Kit 95176	Rotisserie SP-638-BE	Cover BACM153			
Cook Area 3072cm sq	Grill 320mm	Plate 320mm	Height 1200mm	Width 1522mm	Depth 686mm	Weight 63kg*	MJ/hr 58



1600E Series 4 Burner

Graphite Stainless Steel Freestanding BBQ with Side Burner Trolley

BMG1641BBE

Cast Iron cook pack BMG1641BBE		NG Kit 95176	Rotisserie SP-638-BE	Cover BACM154			
Cook Area 3840cm sq	Grill 400mm	Plate 400mm	Height 1200mm	Width 1670mm	Depth 686mm	Weight 77kg*	MJ/hr 72



1600E Series 5 Burner

Graphite Stainless Steel Freestanding BBQ with Side Burner Trolley

BMG1651BBE

Cast Iron cook pack BMG1651BBE		NG Kit 95176	Rotisserie SP-638-BE	Cover BACM155			
Cook Area 4608cm sq	Grill 640mm	Plate 320mm	Height 1200mm	Width 1840mm	Depth 686mm	Weight 91kg*	MJ/hr 86



NEW 7000 Series Classic 5 Burner

Stainless Steel Freestanding BBQ with Side Burner Trolley

BMG7650SAEU

Cast Iron cook pack BMG7650SAEU		NG Kit 95182	Rotisserie SP-638-BE	Cover BACM155			
Cook Area 4480cm sq	Grill 270mm x2	Plate 380mm	Height 1284mm	Width 1758mm	Depth 708mm	Weight 128kg*	MJ/hr 108



NEW 7000 Series Premium 5 Burner

Stainless Steel Freestanding BBQ with Side Burner Trolley

BMF7655SAEU

Cast Iron cook pack BMF7655SAEU		NG Kit 95182	Rotisserie SP-638-BE	Cover BACM155			
Cook Area 4480cm sq	Grill 270mm x2	Plate 380mm	Height 1284mm	Width 1758mm	Depth 708mm	Weight 128kg*	MJ/hr 119



Clubman Stainless Steel

Freestanding BBQ

16440

Stainless Steel cook top 5mm							
Cook Area 4784cm sq	Height 830mm	Width 920mm	Depth 520mm	Weight 65kg*	MJ/hr 72		



Clubman Mild Steel

Freestanding BBQ

16640

Mild Steel cook top 5mm							
Cook Area 4784cm sq	Height 830mm	Width 920mm	Depth 520mm	Weight 65kg*	MJ/hr 72		



PIZZA STONE SET

With Spatula & Pizza Cutter

94935



3-IN-1 CLEANING TOOL

Wire Brush, Scourer & Scraper

94820



12" CLEANING BRUSH

Brass Brush - Box of 6

94946



PROLINE SERIES GRILLER PACK

For ProLine built-in barbecue

BACS102A



UK HOSE & REGULATOR ASSEMBLY

UK Fitment

96581



REAR HEAT SHIELD

for Built-In Barbecue to suit series 1100/1500/1600/3000/7000

BA10RHS



ROAST RACK

Stainless Steel

92965

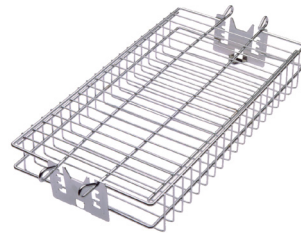

ROTISSERIE SPIT BASKET

Stainless Steel

94835



BAKING DISH

Enamel Finish Deep Baking Dish

92975



PROFESSIONAL BBQ TONGS

Stainless Steel

94968



PROFESSIONAL BBQ SPATULA

Stainless Steel with Rubber Handle

94969



PROFESSIONAL 3 PIECE BBQ SET

Stainless Steel with Rubber Handles

94923

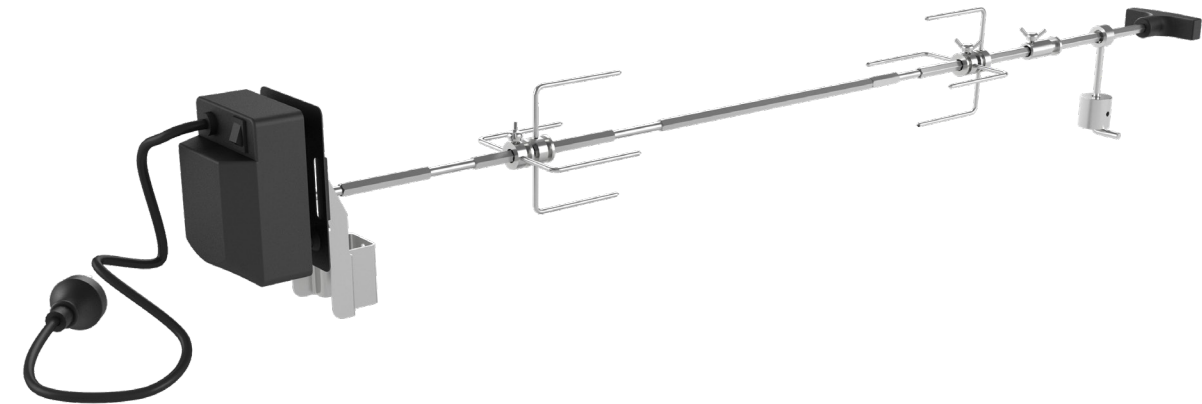

ROTISSERIE KIT

For 3 / 4 / 5 Burner BBQ's

SP-638-BE-UK - BeefEater Europe Universal Rotisserie - UK Plug
 SP-638-BE-EU - BeefEater Europe Universal Rotisserie - EU Plug

*Accessories may differ from image shown due to regional and specification variance.



BURNERS

Proline Burner	0004008617ex
Cast Iron Burner	94701
Cast Stainless Steel Burner	94735



BUILT-IN BRACKETS & TRIM KITS

1100E Series	23115
1100S Series	23117
1200 Series	BA12HS
1500/1600 Series	BA70HS
3000 Series - 3 Bnr / 4 Bnr / 5 Bnr	2313-3/4/5
7000 Series	BA55HS
ProLine (suits roaster & flat lid)	BACS100A
ProLine (suits side burner)	BACS101A



GRILLS

1000 / 1100 Series 160mm Cast Iron Grill - 160mm	94126
1000 / 1100 Series Cast Iron Grill - 320mm	94123
1000 / 1100 Series Cast Iron Grill - 400mm	94125
1200 / 1500 / 1600 Series Cast Iron Grill - 320mm	EW01909-5
1200 / 1500 / 1600 Series Cast Iron Grill - 400mm	EW01909-4
3000 Series Cast Iron 'V' Grill - 160mm	93826
3000 Series Cast Iron 'V' Grill - 320mm	93823
3000 Series Cast Iron 'V' Grill - 400mm	93825



PLATES

1000 / 1100 Series 320mm Cast Iron Plate - 320mm	94133
1000 / 1100 Series 400mm Cast Iron Plate - 400mm	94135
1200 / 1500 / 1600 Series Cast Iron Plate - 320mm	EW01908-5
1200 / 1500 / 1600 Series Cast Iron Plate - 400mm	EW01908-4
3000 Series Cast Iron 'V' Plate - 320mm	93813
3000 Series Cast Iron 'V' Plate - 400mm	93815
3000 Series Cast Iron Plate - 320mm	94323DLX

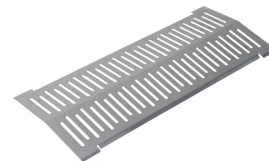

VAPORIZERS / REFLECTORS

1000 Series Vaporizer	060554
1100 Series Vaporizer	478014
1200 / 1500 Series Vaporizer	A13256201
1600 Series Vaporizer	EW02014-4
3000E Series Vaporizer	060546
3000 Series Reflector Plate	060547
S3000S / SL4000 Series Anti-Flare Vaporizer	060557
Proline Panel Heat Distributor	0038006719ex

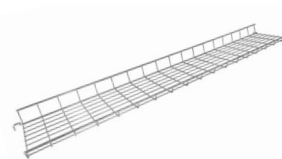

WARMING RACKS

1000 Series Warming Rack - 3 Bnr / 4 Bnr / 5 Bnr	471002-3/4/5
1100 Series Warming Rack - 3 Bnr / 4 Bnr / 5 Bnr	478018-3/4/5
1200 Series Warming Rack - 3 Bnr / 4 Bnr / 5 Bnr	EW01907-3/4/5
1500 Series Warming Rack - 3 Bnr / 4 Bnr / 5 Bnr	A1666040-2/1/3
1600 Series Warming Rack - 3 Bnr / 4 Bnr / 5 Bnr	EW02007-3/4/5
3000 Series Warming Rack - 3 Bnr / 4 Bnr / 5 Bnr	060614-3/4/5



NG CONVERSION KITS

1100 Series	95172
1200/1500/1600 Series	95176
3000E Series	95174
7000 Series	95182
ProLine Series	95184



GREASE MANAGEMENT

1000 Series Grease Tray - 3 Bnr / 4 Bnr / 5 Bnr	471021-3/4/5
1000 Series Grease Collector (inc fixing clips) (471019)	471059
1100 Series Grease Collector	478010
1200 Series Drip Tray - 3 Bnr / 4 Bnr / 5 Bnr	EW01918-3/4/5
1500 Series Drip Tray - 3 Bnr / 4 Bnr / 5 Bnr	A1671420-2/1/3
1600 Series Stainless Drip Tray - 3 Bnr / 4 Bnr / 5 Bnr	EW02024-3/4/5
1600 Series Dark Drip Tray - 3 Bnr / 4 Bnr / 5 Bnr	EW02024-31/41/51
3000 Series Grease Tray - 3 Bnr / 4 Bnr / 5 Bnr	19010-1/3/6
Clubman Grease Cup & Holder	476014
Proline Grease Collector Assembly	AO1840401ex



**FREESTANDING BBQ
ALL WEATHER COVERS**

94463 - Premium
3 Burner Cover 1200/3000

94464 - Premium
4 Burner Cover 1200/3000

94465 - Premium
5 Burner Cover 1200/3000

BACM153 - Premium
3 Burner Cover 1500/1600

BACM154 - Premium
4 Burner Cover 1500/1600/7000

BACM155 - Premium
5 Burner Cover 1500/1600/7000



**BUILT-IN BBQ
ALL WEATHER COVERS**

94493 - Premium
3 Burner Cover 1200/3000

94494 - Premium
4 Burner Cover 1200/3000

94495 - Premium
5 Burner Cover 1200/3000

BACB153 - Premium
3 Burner Cover 1500/1600

BACB154 - Premium
4 Burner Cover 1500/1600

BACB155 - Premium
5 Burner Cover 1500/1600

BACB704 - Premium
4 Burner Cover 7000

BACB705 - Premium
5 Burner Cover 7000



**BUILT-IN BBQ
ALL WEATHER COVERS**

BACS201A
ProLine® Flatlid Cover

BACS200A
ProLine® Roasting Hood Cover

BACS202A
ProLine® Side Burner Cover



ProLine® Built-in roasting hood cover



You will find our products displayed and promoted in many dealer showrooms and specialist online retailers across Europe. Details of these can be found on our website.

We also have a showroom in Ash Vale, Surrey where you can come and talk to our specialist team about range, design or for technical support.

The showroom features our most popular products along with many samples of beautifully crafted worktops used in bespoke outdoor kitchens. You can be sure there is something to suit every style.

Got plans and need inspiration?... No problem, we have a small design team who can design and model your ideas in 3D showing you how your visions will look, making all the necessary adjustments and personalisation to create your dream outdoor kitchen.

BRANDS WE PARTNER WITH...

CABINEX - OUTDOOR KITCHENS OF DISTINCTION

Your dream Outdoor Kitchen can now become a reality... Cabinex are quality DIY outdoor kitchens. Beauty & functionality together with market leading appliances to make your outdoor living area everything you've ever wanted.

Technology & design are combined to offer a cabinetry system that is a pioneer in its class. PVC panels are used together with Cabinex™ patented aluminium framing system, to form a rigid and robust cabinetry solution, ready for years of outdoor entertaining.

The cabinets are also fully weatherproof and supported by a 10-year limited warranty.



PREMIUM SERIES

The premium outdoor kitchen is the outdoor entertainer's dream machine. Big enough to handle large outdoor gatherings, grilling becomes a sheer pleasure with ample room to cook up a feast, or perfect for a small gathering or midweek family dinners.



CLASSIC SERIES

The classic outdoor kitchen will change the way you entertain. Entertaining is just so easy with everything you own at your fingertips, meaning you'll enjoy those moments with family and friends more often.





FRESCO PRO - TASTE LIFE OUTDOORS

Bringing a uniquely fresh and professional approach to outdoor kitchens for our clients, we work alongside homeowners, architects, and developers to create luxury outdoor entertaining areas.

Long established distributors of some of the world's leading and most innovative barbecue brands, we are all placed to provide a system for the ultimate outdoor kitchen. Our kitchens grace outdoor spaces across the globe with clients in Europe, The Middle East, Australasia, and North America.

So, whether it's an urban roof garden, suburban terrace, or a rural mansion, we will draw on our years of design, construction, and product knowledge to deliver an alfresco space that you will be proud of for many years to come.

The choice is yours to make it your own with the variety of different modules that can be combined to suit all needs. Once the framing system has been assembled you can now add your door skins, worktop, and waterfalls. The door skins can be fabricated from either a classic aluminium composite or premium dekton. These door skins are smooth and durable whilst being elegant and will compliment any outdoor area. These outdoor kitchens are tailored to accommodate BeefEater or many other leading quality barbecue brands.

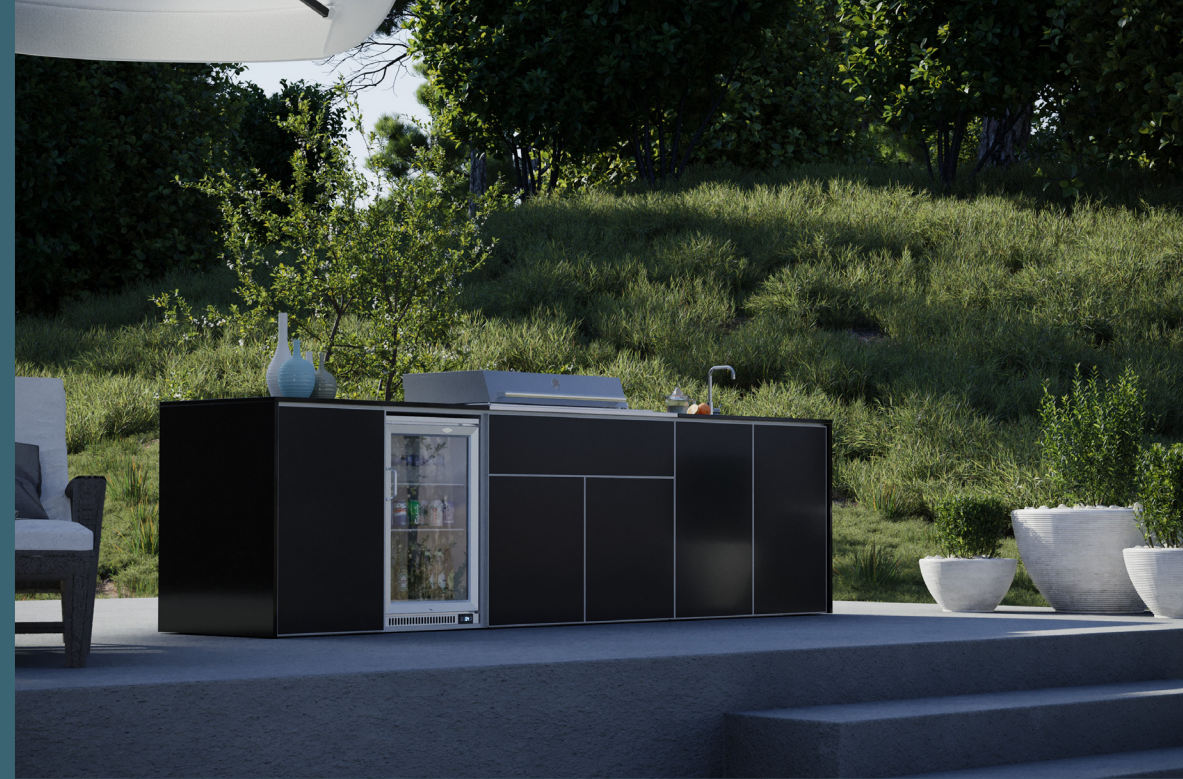



Beef Eater



2023



beefeaterbbqeuropa.co.uk



[@beefeaterbbq.europa](https://www.instagram.com/beefeaterbbq.europa)



[Beefeaterbbqeuropa](https://www.facebook.com/Beefeaterbbqeuropa)

LIFE TASTES BETTER OUTDOORS

For more information on all BeefEater products, or for dimension and installation information, call into your retailer, phone or email our customer care team or visit our website.

BeefEater Europe

PO Box 1238

Cheddar

BS27 9AH

United Kingdom

Phone +44 (0) 1934 743322

Email sales@beefeater.europa.co.uk